



**AT LAST A STURDY, WELL MADE ATTIC STAIR!**  
 Easy to install, easy to use... From any standpoint - design, functionality, strength, energy savings, ease of use and installation, RAINBOW PRESTIGE attic stairs are unlike anything you've seen.

- Features:**
- Strong 3/4" melamine finish MDF frame.
  - Steel frame with 2" self finishing flange (no trim casing needed).
  - All steel treads - 350 lb. capacity.
  - All steel, 4' telescopic handrail for home safety when going up or down stairs.
  - 2" Styrofoam core door with double weatherstripping - R15 for energy conservation.
  - Powder coated steel "scissor" in color. Self adjusting stair rise.
  - Protective floor bumpers.



Scissor Color	Rough Opening	Stair Frame Dimensions	Floor to Ceiling Height	Tread Width
white	22-1/2" x 36"	22" x 35-1/2"	7'4" - 9'6"	12"
yellow	22-1/2" x 54"	22" x 53-1/2"	7'4" - 9'10"	12"
orange	22-1/2" x 54"	22" x 53-1/2"	9'10" - 11'6"	12"
blue	25-1/2" x 54"	25" x 53-1/2"	7'4" - 9'10"	14"
green	30" x 60"	29-1/2" x 59-1/2"	7'4" - 9'10"	16"
red	30" x 60"	29-1/2" x 59-1/2"	9'10" - 11'6"	16"

**STAR Telescoping Attic Stair**  
 The works of our top-of-the line unit at a lower cost!

- Features:**
- Strong 3/4" melamine finish MDF frame.
  - Insulated door with weatherstripping to reduce drafts and air leakage from the attic.
  - Powder coated gray color steel "scissor".
  - All steel tread - 350 lb. capacity. Residential use only.
  - Protective floor bumpers.



Model Number	Rough Opening	Stair Frame Dimensions	Floor to Ceiling Height	Tread Width
S2254	22-1/2" x 54"	22" x 53-1/2"	7'4" - 10'	12"
S2554	25-1/2" x 54"	25" x 53-1/2"	7'4" - 10'	14"

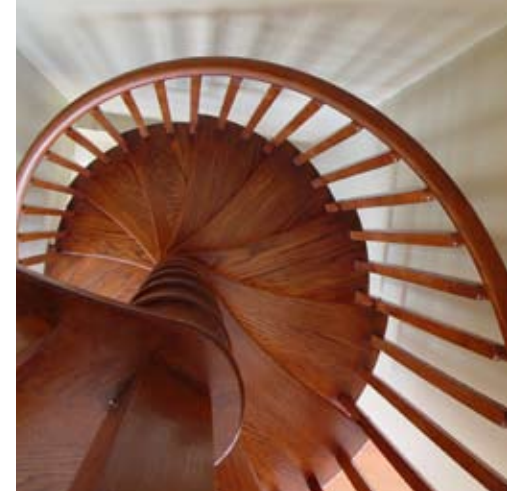

DISTRIBUTED BY NORTH ATLANTIC CORP  
 1255 GAR Highway • Somerset, MA 02726  
 www.northatlanticcorp.com  
 Email: info@cooperstairworks.com  
 Technical Support: 508.235.4397  
 Fax: 508.235.4436



Gamia Metal



Gamia Wood



MISTERSTEP presents the simple beauty of spiral staircases in two products that offer accurately finished details, a very affordable cost, and a balance of materials that adapt to every environment.

GAMIA METAL (Brio), with neutral light gray metal treads, and GAMIA WOOD (Phola), with wood steps in a natural oak finish, are graced by your choice of rails in custom carved wood rounds or the economical, flexible, "Moplen" handrail in black to match the durable finish on the metal balusters that complete the system.

**Product Features:**

- **Availability** - in stock at distributors, means NO manufacturing lead time.
- **Prefinished Components** - speed up and complete the project upon assembly.
- **Design flexibility** - universal platform in 3 diameters.
- **Reversible** - for clockwise or counter-clockwise direction.
- **Adjustable** - in height from 8-1/4" to 9-1/16" per riser and fit any floor-to-floor height.
- **Baluster spacing** - meets the building code 4" sphere rule specification.
- **Warranty** - 2 Years
- **Stock Sizes** - 47", 55", 63" Diameters
- **Finished Opening** should be 4-6" larger than diameter of stair.

**Custom Wood Rail Options**

Available in oak, poplar, and maple (short lead time required).

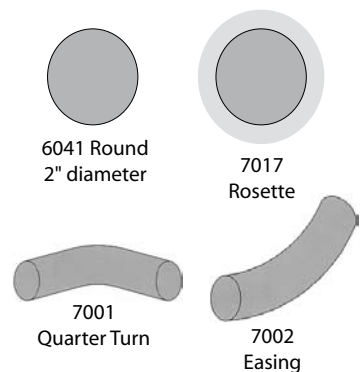

**Universal Platform**

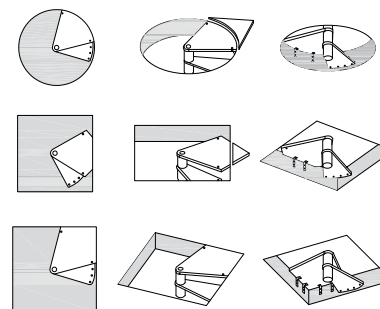

Number of steps + the landing platform	Adjustment range of the floor to floor height
10 + Platform	90¾" - 99"
11 + Platform (STOCK)	99" - 108"
12 + Platform	107¼" - 117"
13 + Platform	115½" - 126"

After 13 steps add 1 intermediate post

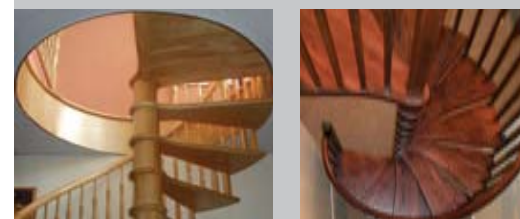

Custom all wood spiral stair using a classic newel and baluster style. RAVENWOOD Stairways is located on Canada's East Coast on beautiful Prince Edward Island. In an area of the world where heritage and tradition are still held in the heart, generations of woodworkers, boat builders and carvers have passed their craft on.

Our spiral staircases have something special and enchanting about them and we are pleased to offer you a custom made wood spiral in the form of a kit.

Hand Crafted. Precision Made.

**Product Features:**

- Available with short lead time.
- Assembled, parts numbered and shipped K.D.
- All wood construction
- Choice of oak, maple and spruce.
- Choice of three rail and baluster options.
- Warranty - 2 Years
- Available in 47", 55" and 63" diameters.
- Finished Opening should be 4"-6" larger than diameter of stair.

**Rail Options**

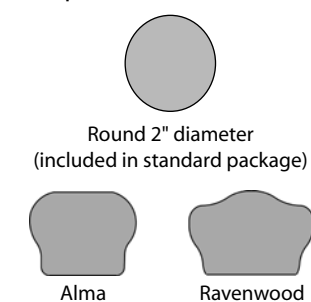

**Newel and Baluster Options**

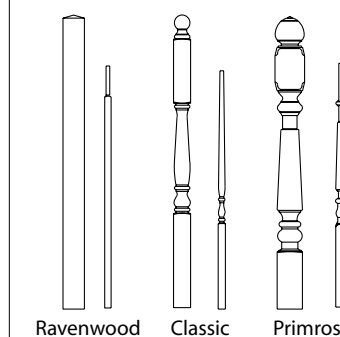

**Platform Type**

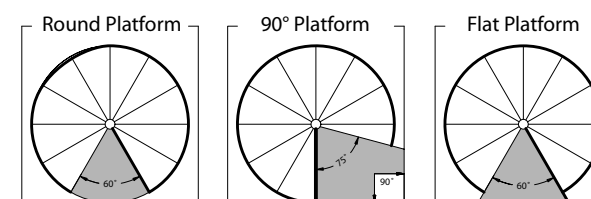

Number of steps + the landing platform	Adjustment range of the floor to floor height
10 + Platform	93½" - 104½"
11 + Platform (standard)	102" - 114"
12 + Platform	110½" - 123½"
13 + Platform	119" - 133"

No minimum rise required to achieve head room with 90° platform